

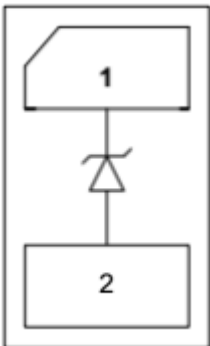

Description

The JLE12ULD2-2 is an uni-directional TVS diode, utilizing leading monolithic silicon technology to provide fast response time and low ESD clamping voltage, making this device an ideal solution for protecting voltage sensitive data and power line. The JLE12ULD2-2 complies with the IEC 61000-4-2 (ESD) with $\pm 30\text{kV}$ air and $\pm 30\text{kV}$ contact discharge. It is assembled into a small DFN1006-2 (1.0 \times 0.6 \times 0.5mm) package. The small size and high ESD surge protection make JLE12ULD2-2 an ideal choice to protect cell phone, digital cameras, audio players and many other portable applications.

Circuit Diagram



Circuit and Pin Schematic

Marking Diagram



Transparent top view

2P:Device Marking Code

Features

- * 350W peak pulse power (8/20 μs)
- * Low leakage: nA level
- * Operating voltage: 12V
- * Ultra low clamping voltage
- * One power line protects
- * Complies with following standards:
 - IEC 61000-4-2 (ESD) immunity test
 - Air discharge: $\pm 30\text{kV}$
 - Contact discharge: $\pm 30\text{kV}$
 - IEC61000-4-5 (Lightning) 14A (8/20 μs)
- * Package: DFN1006-2
- * ROHS Compliant

This product does not contain lead, mercury, cadmium, Hexavalent chromium, polybrominated biphenyls (PBB) and polybrominated diphenyleths (PBDE), and are considered RoHS compliant.

Applications

- * Fast-charge battery chargers
- * Power management system
- * Cellular Handsets and Accessories
- * Personal Digital Assistants

Ordering Information

Part Number	Packaging	Reel Size
JLE12ULD2-2	10000/Tape & Reel	7 inch



JLE12ULD2-2

Absolute Maximum Ratings ($T_A=25^\circ\text{C}$ unless otherwise specified)

Parameter	Symbol	Value	Unit
Peak Pulse Power (8/20 μs)	Ppk	350	W
Peak Pulse Current (8/20 μs)	IPP	14	A
ESD per IEC 61000-4-2 (Air)	VESD	± 30	kV
ESD per IEC 61000-4-2 (Contact)		± 30	
Operating Temperature Range	TJ	-55 to +125	$^\circ\text{C}$
Storage Temperature Range	Tstg	-55 to +150	$^\circ\text{C}$

Electrical Characteristics ($T_A=25^\circ\text{C}$ unless otherwise specified)

Parameter	Symbol	Test Condition	Min	Typ	Max	Unit
Reverse Working Voltage	V_{RWM}				12	V
Breakdown Voltage	V_{BR}	$I_T = 1\text{mA}$	13.3		17.8	V
Reverse Leakage Current	I_R	$V_{RWM} = 12\text{V}$			100	nA
Clamping Voltage	V_C	$I_{PP} = 1\text{A}$ (8 x 20 μs pulse)			15	V
Clamping Voltage	V_C	$I_{PP} = 14\text{A}$ (8 x 20 μs pulse)			25	V
Junction Capacitance	C_J	$V_R = 0\text{V}, f = 1\text{MHz}$		65		pF

Portion Electronics Parameter

Symbol	Parameter
I_T	Test Current
I_{PP}	Maximum Reverse Peak Pulse Current
V_C	Clamping Voltage @ I_C

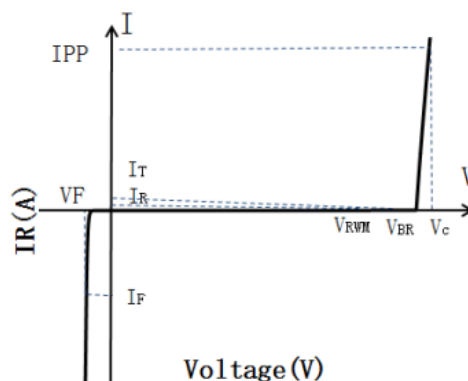



JLE12ULD2-2

Typical Performance Characteristics ($T_A=25^\circ\text{C}$ unless otherwise Specified)

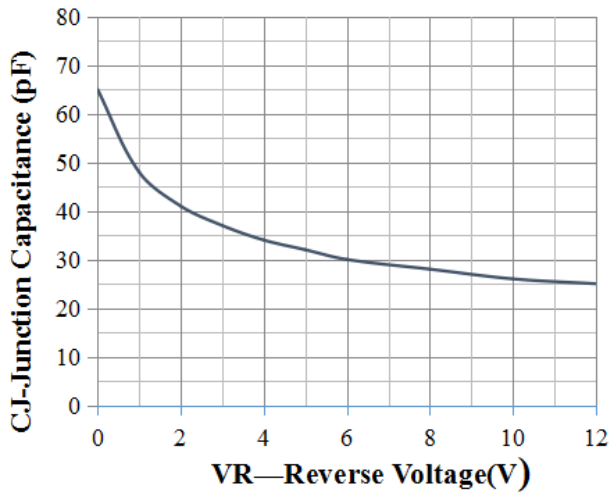

Junction Capacitance vs. Reverse Voltage

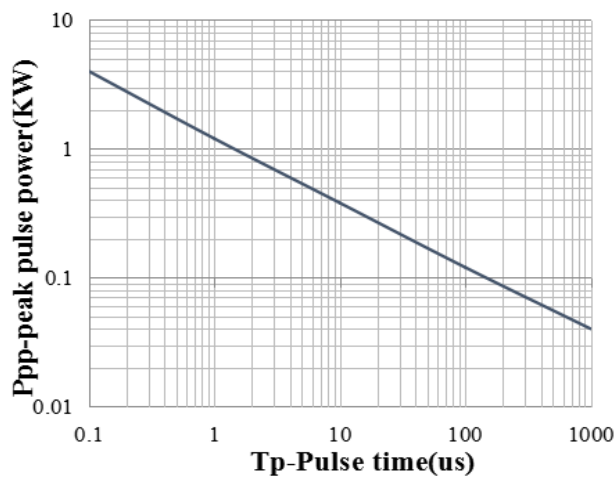

Peak Pulse Power vs. Pulse Time

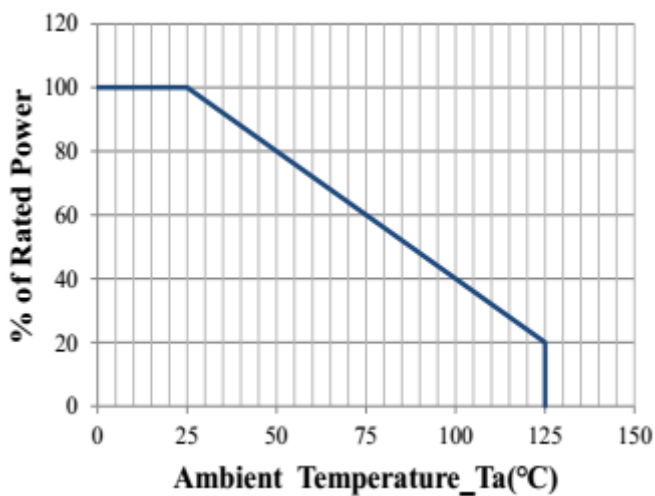

Power Derating Curve

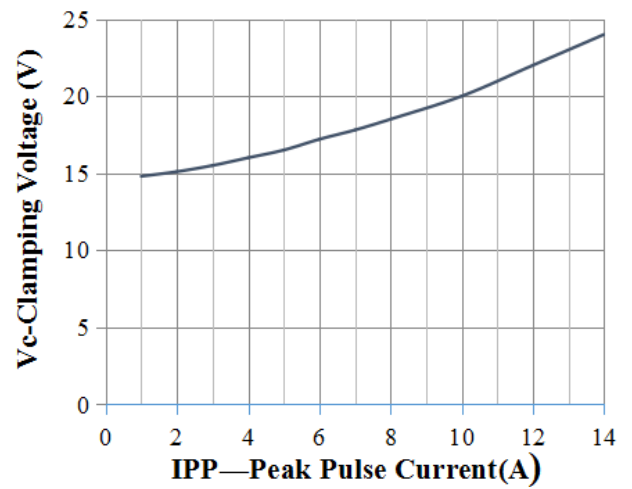

Clamping Voltage vs. Peak Pulse Current

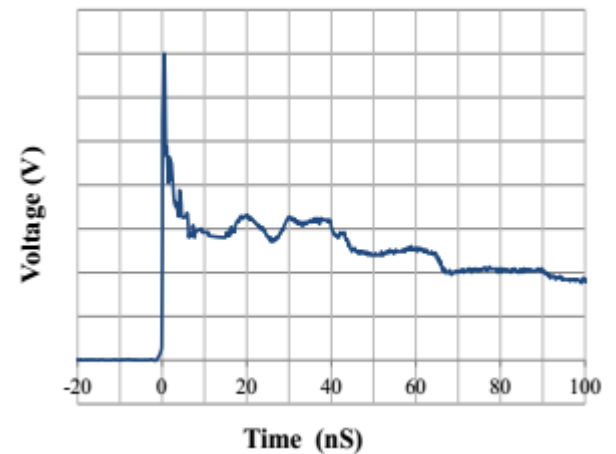

IEC61000-4-2 Pulse Waveform

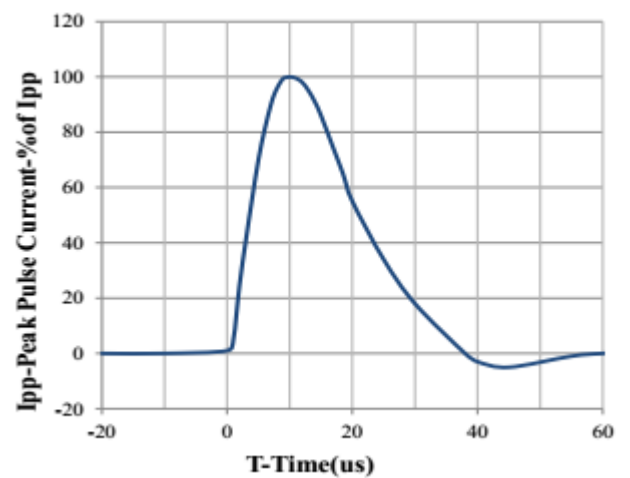

8 X 20us Pulse Waveform



JLE12ULD2-2

DFN1006-2 Package Outline Drawing

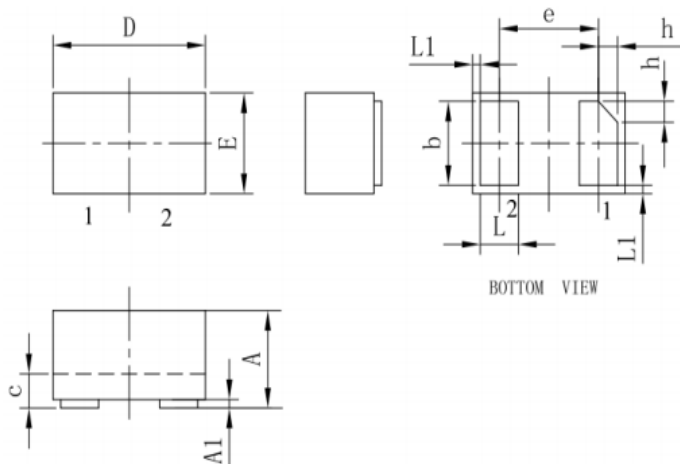

SYM	DIMENSIONS					
	MILLIMETERS			INCHES		
	MIN	NOM	MAX	MIN	NOM	MAX
A	0.45	0.50	0.55	0.018	0.020	0.022
A1	0.00	0.02	0.05	0.000	0.001	0.002
b	0.45	0.50	0.55	0.018	0.020	0.022
c	0.12	0.15	0.18	0.005	0.006	0.007
D	0.95	1.00	1.05	0.037	0.039	0.041
e	0.65 BSC			0.026 BSC		
E	0.55	0.60	0.65	0.022	0.024	0.026
L	0.20	0.25	0.30	0.008	0.010	0.012
L1	0.05REF			0.002REF		
h	0.07	0.12	0.17	0.003	0.005	0.007

Suggested Land Pattern

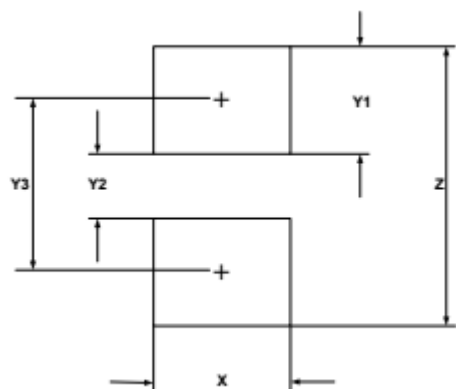

SYM	DIMENSIONS	
	MILLIMETERS	INCHES
X	0.60	0.024
Y1	0.50	0.020
Y2	0.30	0.012
Y3	0.80	0.032
Z	1.30	0.052

NOTICE

Jelan-Link reserves the right to make changes without further notice to any products here in.

Only obligations are those in the Jelan-Link Standard Terms and Conditions of Sale and in no case will Jelan-Link be liable for any incidental, indirect, or consequential damages arising from the sale, resale, use, or misuse of its products.